

Première expérience italienne avec un câble optique enterré.

First Italian Experiment with Buried Optical Cable

[B. Catania, L. Michetti, F. Tosco (CSELT), E. Occhini (Pirelli), L. Silvestri (Sirti), II ECOOC, Paris, 27-30 September 1976, Communication X.3, Session X "Mesures sur le terrain" (On-site measurements), p. 315-322 of Proceedings]

RESUMÉ

L'expérience acquise dans le passé avec les câbles conventionnels pour télécommunications a montré que les essais en conditions effectives de pose donnent des indications qui ne peuvent pas être obtenues avec des essais en laboratoire. Pour cela une expérience a été décidée avec un câble optique enterré, fabriqué par Industrie Pirelli S.p.A. Milan et installé par SIRTI S.p.A. Milan, à l'intérieur du terrain du CSELT à Turin. Cette première expérience sur le terrain, appelée expérience COS 1, a surtout l'objectif de vérifier les possibilités d'emploi des câbles optiques sur des parcours interurbains.

Les expériences sont effectuées par CSELT et consistent essentiellement dans la mesure, à certains intervalles de temps, de l'atténuation, dispersion et diaphonie sur les fibres optiques contenues dans le câble et dans l'examen de leur corrélation avec les conditions d'ambiance, comme la température, l'humidité et les vibrations, qui sont aussi mesurées. Une mesure de la radioactivité du sol dans la tranchée a aussi été faite avant la pose du câble.

Les résultats des mesures effectuées jusqu'ici sont très encourageants et pour cela une deuxième expérience (appelée COS 2) a été décidée, ayant l'objectif d'essayer un deuxième câble optique posé en zone urbaine.

ABSTRACT

The experience gained in the past with conventional telecommunication cables has shown that tests in actual laying conditions give indications that cannot be obtained by laboratory test. Therefore a trial has been planned with a buried optical cable, developed by Industrie Pirelli S.p.A. Milan and installed by SIRTI S. p. A., Milan within the CSELT premises in Turin. This first field trial, called COS 1 experiment, is mainly aimed to assessing the possibility of implementation of optical cables in intercity routes.

The experiments are performed by CSELT and consist mainly in the measurement of attenuation, dispersion and crosstalk on the optical fibers contained in the cable, at certain time intervals, and in the investigation of their correlation with the environmental conditions, such as temperature, humidity and vibrations, which are also measured. A check of the radioactivity of the soil in the trench was also done, before the cable laying.

The results of the tests performed up to now are very encouraging and therefore a second field experiment (called COS 2) has been planned to test a second optical cable in urban areas.

1. INTRODUCTION

COS 1 (which is the Italian acronym for "Buried Optical Cable") is the first of a series of experiments to be performed in order to assess the possibility of implementation of optical cables in the Italian telecommunication network.

In this first experiment the construction, installation and field test conditions of the cable were chosen fairly near to those which are encountered in actual operation of the cables in *intercity routes*. The second experiment planned (COS 2) will be performed to assess the practicability of optical cables in urban areas and will include pulling of the cable through *urban ducts*.

In the frame of the development agreement signed on October 15, 1973 between Industrie Pirelli S. p. A., Milano, Corning Glass Works, Corning, N. Y. (U.S.A.) and CSELT S.p.A., Torino, COS1 experiment was conducted jointly by Pirelli, who took care of the cable construction, using optical

waveguides supplied by Corning, and CSELT, who took care of the experiment planning and execution, test laboratory setup and routine testing.

A characteristic of the COS 1 experiment was to limit the transmission tests to the three essential optical quantities, i.e. attenuation, dispersion and crosstalk, as functions of time, whereas the environmental conditions (temperature, water column, vibrations) were monitored at the same time. The ionizing radiation level was measured only once along the trench, before the cable was buried.

Parallel to these field tests, other experiments were conducted in the Laboratory, at CSELT, with digital transmission at both 34 Mb/s and 140 Mb/s rate on single fibers, to correlate the optical characteristics with the electrical transmission characteristics. Given the excellent agreement between calculated and measured performance in these latter experiments [1] it is expected that the information gathered by the COS 1 experiment by measuring the three aforesaid optical quantities will be sufficient to draw basic conclusions on actual system performance.

In the following the description of the COS 1 experiment and the results gathered up to now are illustrated. However, we expect to continue the tests on this first cable at least for a total period of 2 years from the completion of the installation (March 1976).

The installation of the optical cable for the COS 1 experiment was performed by SIRTI S. p. A., Milano, as subcontractor of CSELT, using, as far as possible, conventional techniques as employed in intercity routes.

2. CABLE MANUFACTURING

The main problems in manufacturing a cable containing optical fibres are essentially mechanical. Fibres must not break during the cabling operations and must be adequately protected against mechanical stresses during the installation and the service life of the link. Furthermore, the fibre transmission characteristics must remain constant, independent of the thermal and mechanical stresses to which the cable will be submitted during manufacturing and life.

In order to investigate and overcome these problems, and before the manufacturing of the cable used in the COS 1 experiment, experimental facilities with machinery of special design were set up in the R & D Laboratories of Industrie Pirelli (Milan).

These facilities include an extrusion line for the application of a suitable loose thermoplastic jacketing over the fibre. This line is designed to permit a careful control of both the mechanical tension applied to the fibre and of the thermal retraction of the coating material.

Also included is a laying-up line which has been designed such that damage to the coated fibres is avoided during the laying-up operation. This machine allows the handling of the fibres without torsion and with a mechanical tension less than 0.1 kg. The total tension applied to the cable core is also maintained at a low level of 2 to 3 kg.

Finally a conventional plastic sheathing line with the possibility of applying poly-lam is included which completes the cable manufacturing cycle.

Several 1 km lengths of optical fibre cable were manufactured and tested with satisfactory results. The mechanical breakage record of the fibres has been very favorable: only two breaks occurred during a total of 30 km of fibre handled.

A major problem which was solved was the maintenance of a constant fibre attenuation value during the cable manufacturing process. This was solved by the introduction of a suitable strength member into the cable, which also gives the cable an adequate resistance to mechanical tensions. Two cable lengths were tested under thermal cycling (from -5 °C to +30 °C) and were subjected to a transportation test on a rough 150 km route without observing significant changes in the transmission characteristics of the fibres.

The construction of the cable used for the COS 1 experiment is represented in fig. 1.

Six of the twelve elements shown are jacketed fibres, while the other six elements are fillers. Obviously these filler elements could have been replaced by jacketed fibres^(*). Two of the six fibres

^(*)This was not done mainly for reasons of cost

used in the cable were of Corning graded index type, while the remaining four were of Corning step index type (see table 1).

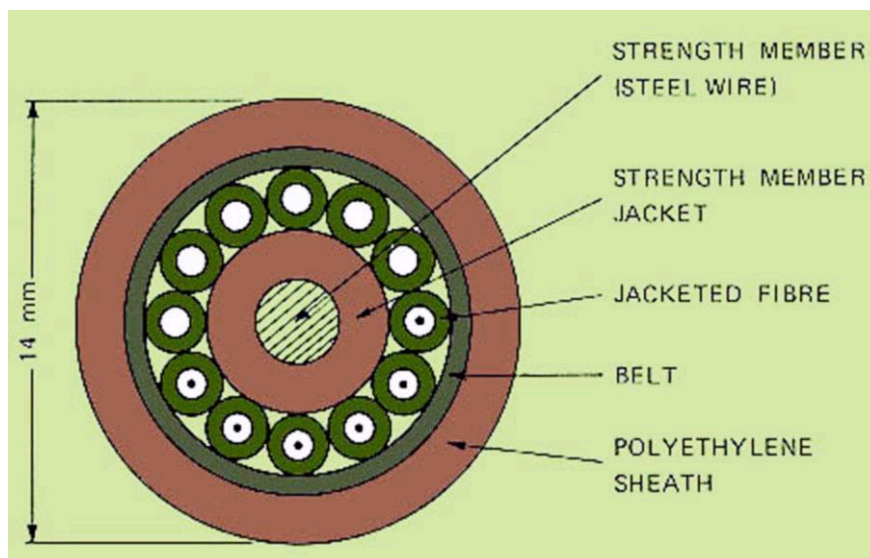

Fig. 1 - Cable cross section (not in scale)

It is to be noted that most of these fibres were produced by Corning more than one year ago and therefore (particularly the graded index types) are not of the highest quality available today. The outer diameter of the cable is about 14 mm and its weight is 190 g/m; however, it is to be said that, in this first cable, practically no efforts were made to reduce either or both the aforesaid quantities.

FIBER POSITION	INDEX PROFILE	INITIAL ATTENUATION @ 820 nm
pos 5	step	9.3 dB/km
pos 6	step	4.8 dB/km
pos 7	graded	8.3 dB/km
pos 8	graded	8.0 dB/km
pos 9	step	4.9 dB/km
pos 10	step	4.5 dB/km

Table 1 - Characteristics of the six fibres used in the experimental cable

3. CABLE LAYING AND PRESSURIZATION

The optical cable used in the COS 1 experiment was 984 m long and was laid down in three turns in an approx. 150 m long trench (see fig. 2); this trench was dug in an area within the CSELT premises in Turin. As shown in the figure, at points A and F the cable may be laid to follow two alternative paths, to accommodate differential lengths of 10 m and 50 m respectively (see also fig. 3, in which a detail of point A is shown); this was done also in view of future experiments, with different lengths of cable.

It is to be noted that the minimum bending radius to which the cable is subjected along the trench is never below 1 m. However, the shipping drum in which the cable was wound had a diameter of 0.6 m. The trench cross section, is shown in fig.4, referring to the straight parts of the path. From this figure it can be seen that the cable is laid at a depth of about 70 cm, and is housed with go and return stretches laid inside two separate channels made with concrete boxes, which are filled with sand (to give protection against mice) and are protected with reinforced concrete covers. With three turns per cable along the path, up to two more cables, each one about 1 km long, can be accommodated in the future in the same concrete boxes. One 20-pair telephone cable, to be used for temperature measurements, was laid in the same concrete boxes as the optical cable. In addition to that, one 50-

pair telephone cable was laid down aside of the concrete boxes, to be utilized for sending the test signals from the various test points to the test laboratory, as better described in the following.

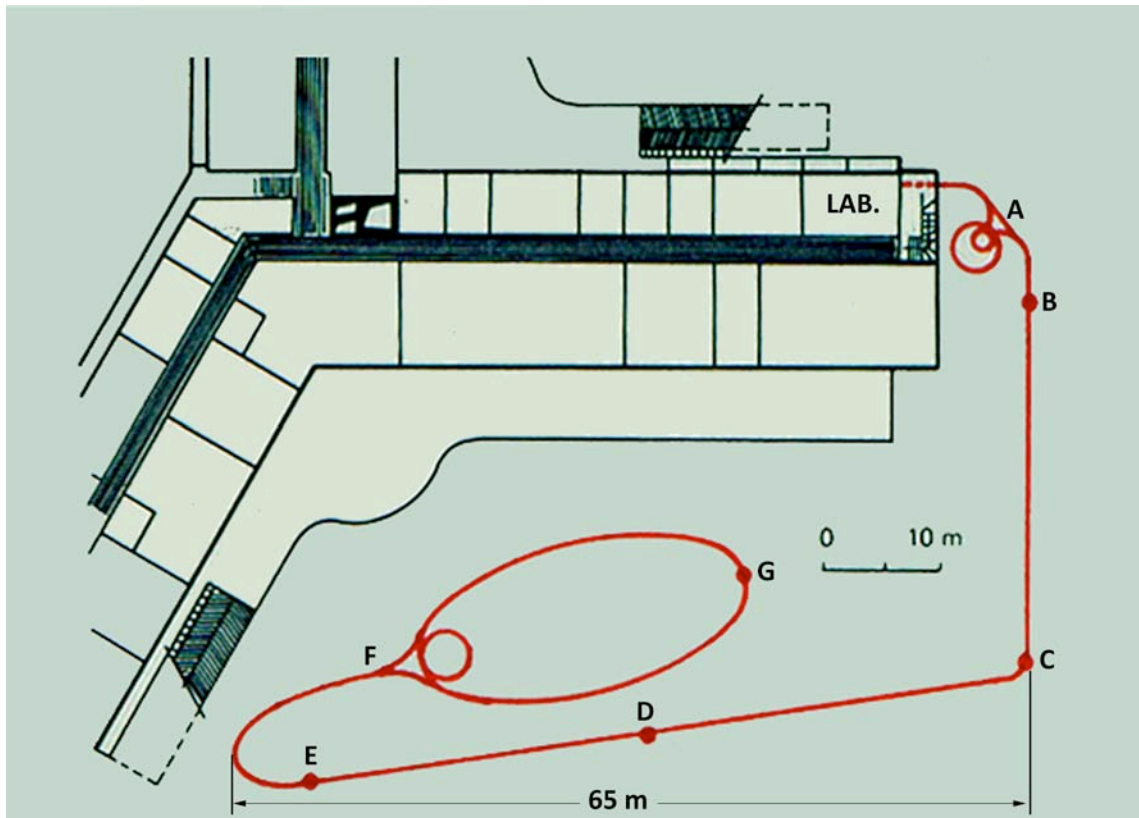

Fig. 2 - Cable route



Fig. 3 – Cable trench during laying¹

Both cable ends enter the test laboratory, which is located in a room below the ground level, in the CSELT building; they are first passed through a special water drain box and then are wound on a drum for a length of about 25 meters per end, to allow performing a number of attenuation measurements. The cable laying was carried out by means of a normal lorry, adapted for telephone

¹ Original photo “Detail of the cable route at point A during laying” not available.

cable laying, as clearly shown in the photograph of fig. 3. The laying operation did not present more difficulties than the laying of a usual telephone cable; however, a greater care was used, avoiding, as far as possible, the pulling of the optical cable along the trench, and confining the pulling action only to the unwinding of the cable from the shipping drum.

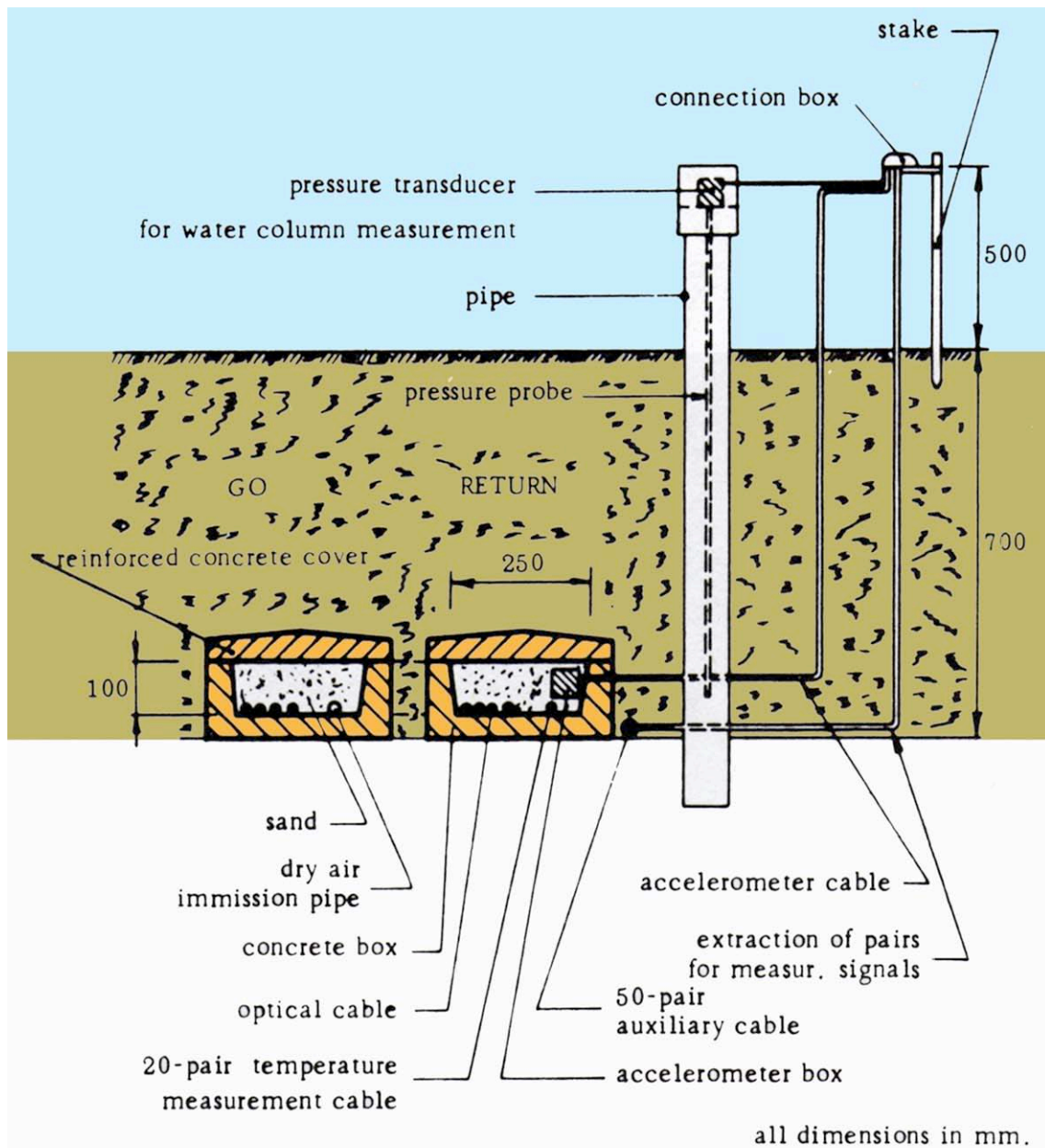

Fig. 4 - Cable laying and test transducers fitting

Even if, from previous experiments, conducted elsewhere, it was found that optical cables are not adversely affected by the presence of moisture or water, it has been thought advisable, in this first field trial, to place the optical cable in the same conditions as telephone cables, i. e. with pressurization of the continuous flow type.

Obviously, the pressurization may be removed in the future, whenever it may be desired to observe the difference, if any, in the performance of the cable in presence of water.

The utilized gas is dry air, with a dew point lower than -30°C ; the dry air is injected in the midpoint of the cable length (point G of fig. 2) by means of a small polyethylene covered copper pipe. The two ends of the cable, just ahead of the drum placed in the test laboratory, are made tight by means of two gas seals, over which two test valves are placed; the dry air used for pressurization flows freely from these valves.

The input air pressure at the midpoint of the optical cable is 0.5 Kg /cm^2 and, owing to the remarkable flow resistance of the cable (approx. $20.000 \mu\text{pneus}$), a flow of a few normal-l/h [] comes out from each end. The dry air input flow is controlled by means of a flow meter having a photoelectric cell adjustable alarm, while an automatic dew point meter installed on the control rack placed in the test laboratory indicates the dew point of the air at both the input and the two output valves of the cable. Finally, the above described pressurizer is provided with an automatic device which stops the flow when the dew point of the air at the input point of the cable exceeds $-20 \text{ }^\circ\text{C}$. It is to be noted that the pressurization system has been foreseen to simultaneously feed two additional optical cables, similar to that used in the COS 1 experiment.

4. ENVIRONMENTAL MONITORING

A monitoring system has been installed for measuring and recording the environmental conditions of the buried optical cable, in order to study the correlation between these conditions and the cable performances. The measured parameters are: the cable temperature, the height of the water column above the cable, the vibrations in the neighborhood of the cable and the characteristics of the dry air used for the pressurization of the cable. Moreover, the radioactivity of the soil has been measured, together with the overall ionizing radiation level along the trench.

For the *temperature* measurement a 20-pair paper insulated telephone cable has been laid aside the optical cable, within the same concrete boxes. A few pairs of this cable have been connected in cascade, to obtain a value of the total DC resistance of 100 ohm at the temperature of 0°C . The measurement of the DC resistance of this auxiliary cable is performed using a measuring set which gives directly on a digital display the value of the temperature in $^\circ\text{C}$. A linear analog output of the measuring set is connected to a chart recorder. In fig. 5 the temperature measured in the period from April to June 1976 is reported.

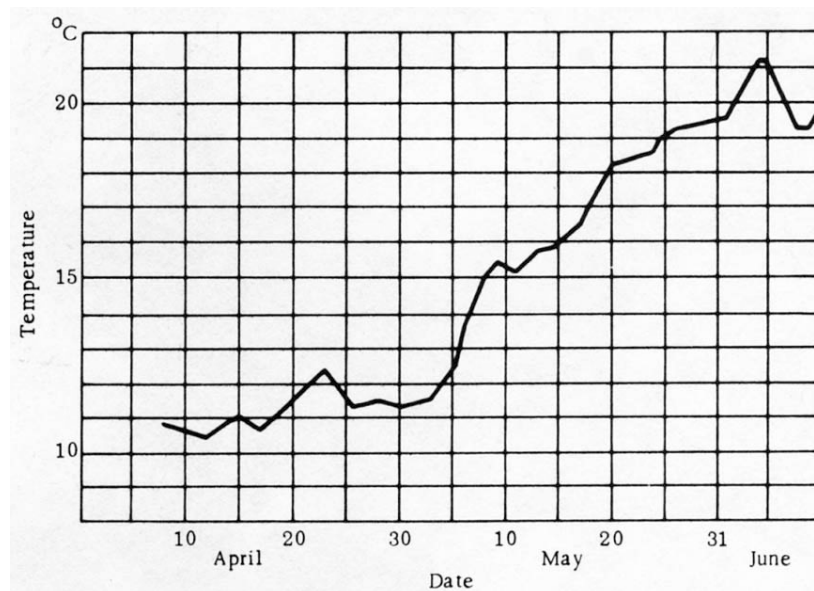

Fig. 5 - Average temperature of the optical cable

The height of the *water column* above the cable and the vibrations existing in the vicinity of the cable may be functions of the position along the optical cable path; therefore five test locations (points B, C, D, E, G, of fig. 2) have been provided along the path. Moreover, a 50-pair telephone cable has been laid near the optical cable, outside of the concrete boxes; in each of the five test locations ten pairs are extracted from this auxiliary cable and linked to a connection box installed off the ground. These pairs are used for the remote power feeding of the measuring equipment installed in each location and for the transmission of the measurement signals to the test laboratory. In fig. 4 one of these test locations is shown. To perform the water column measurement, a small well has been dug in each test location and a plastic pipe has been introduced in it; a pressure transducer has been

installed at the top of the pipe, giving an output voltage proportional to the water level in the pipe. The output signals from the five test locations, sent to the test laboratory through the auxiliary 50-pair cable, are measured by five voltmeters adjusted to indicate directly the water column in mm and are recorded by a chart recorder. Up to now, the measuring system has never indicated the presence of water above the cable, due to the good draining property of the soil.

For the measurement of the *vibrations* to which the cable is subjected, a system of three inertial accelerometers oriented in three orthogonal directions is provided in each test point² (°). The electrical outputs of the accelerometers are sent to the test laboratory through the auxiliary 50-pair cable. The sensitivity of this measuring system is of the order of 0.01 g, where g indicates the gravity acceleration (due to the noise on the pairs of the auxiliary cable). As an example, a 20-tons lorry and a 15-tons track-bulldozer moving aside of the cable path produce a peak indication respectively of ± 0.03 g and ± 0.1 g (fig. 6). In these conditions the fibre attenuation was absolutely constant.

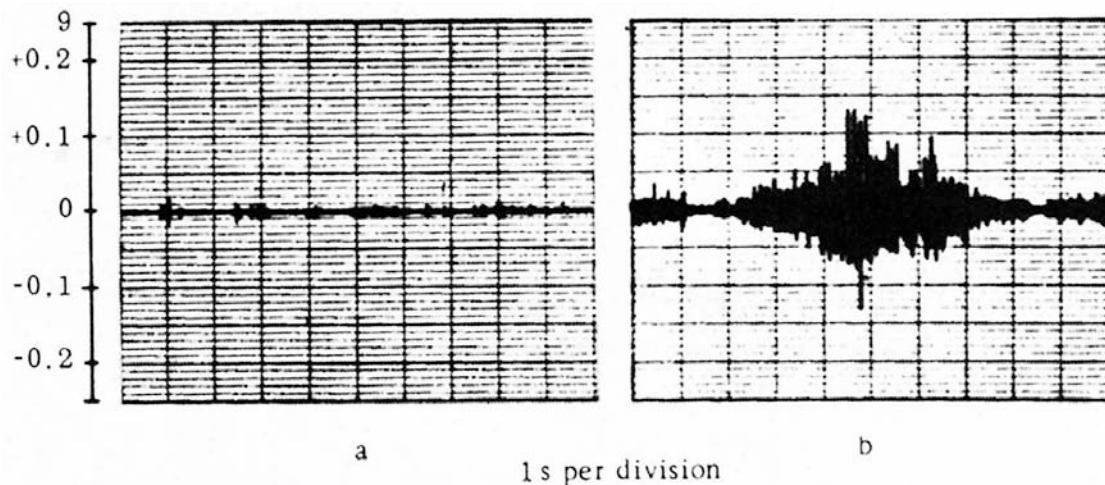

Fig. 6 - Examples of accelerometer recordings, caused by a) a lorry, b) a bulldozer, moving slowly (speed < 20 km/h) at ground level near the trench

Note: the simultaneous record of the fibre attenuation has not been reported because in these conditions it was absolutely constant

A heavy traffic road situated approximately 100 meters from the cable path does not produce noticeable indications of the accelerometer.

The characteristics of the dry air used for the pressurization are sporadically checked by taking out samples from the ends of the cable, to be submitted to chemical analysis.

During the laying of the cable, when the trench was open, a rough test of the overall radioactivity at the bottom of the trench has been performed using a dosimeter; the radioactivity resulted, as it was foreseeable, below the measurement sensitivity, which was 0.1 milliroentgen/h. A few samples of the soil have also been taken and their radioactivity was measured at the Physics Department of the Turin University using a sodium iodide detector. The measured values are nearly equal to those given by the background radiation (most of all due to cosmic radiation) and correspond to an absorbed dose of about 20 m rad/year, in the energy range from 50 to 1000 KeV.

5. TEST RESULTS

The transmission behavior of the fibres used in the optical cable is tested essentially by measuring their spectral attenuation and pulse distortion.

These measurements were carried out on the fibres after each stage of the cable manufacturing process, transport and laying; they are now periodically repeated during the field trial. In addition, in this second and longer part of the COS 1 experiment, besides the environmental conditions described

² Up to now only one accelerometer has been placed; the rest of them will be installed, if necessary, after the gathering of the first significant results

above, the received signal level from a source of monitored optical power firmly coupled to one of the six fibres in the cable is continuously recorded.

The spectral attenuation measurement is performed by a well known method, consisting in exciting the fibre by means of a suitable optical source and measuring the output power a) from the whole length of the fibre under examination, and b) from a very short length (e. g. 1 meter) of the same fibre; during this measurement the launching conditions are kept fixed (see scheme of fig. 7, which refers to the experimental apparatus used at CSELT and also the photograph of fig. 8).

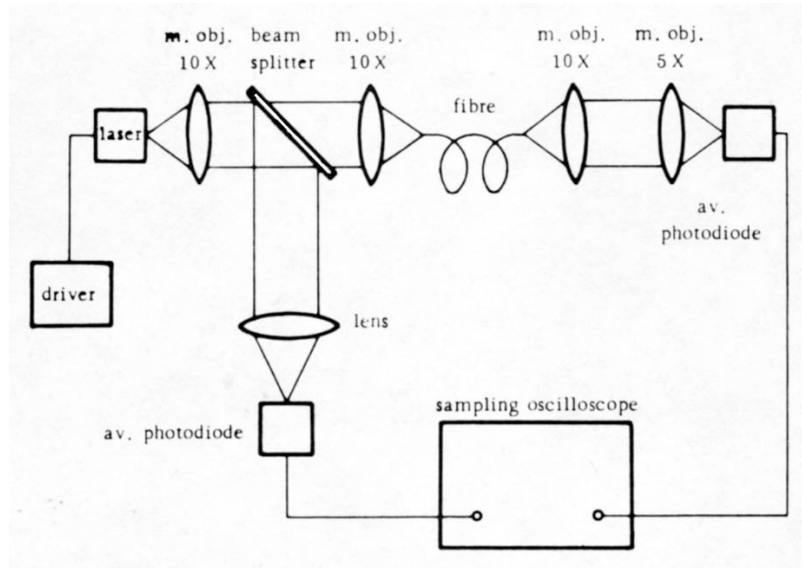

Fig. 7 - Spectral attenuation measurement

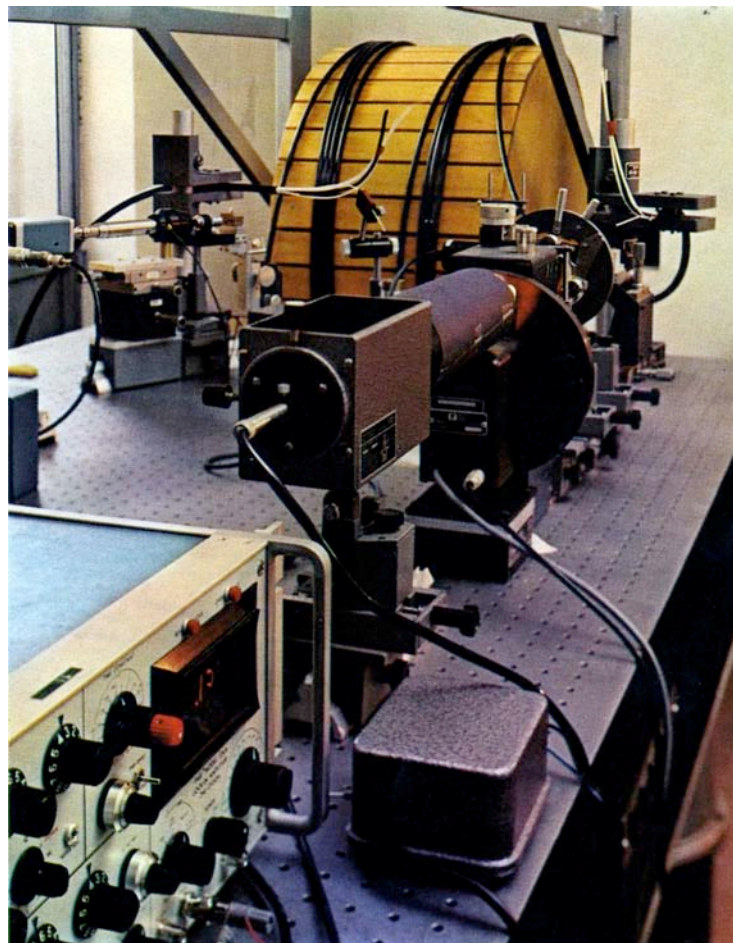

Fig. 8 - Measurement apparatus for optical cable test

This kind of measurement leads to a certain spread of values when different measurements are carried out on the same fibre: the main source of errors consists in the difficulty of controlling both the input and the output coupling conditions, and we estimate this error to be about 0.3 dB; the errors due to the optical source, the detector and the electronics noise are negligible compared to the former one.

The pulse broadening caused by the fibre is also measured by a well known method: it consists in sending a very short (0.5 ns) optical pulse into the fibre and displaying the output pulse from the fibre itself: a comparison between the two pulses allows, if required, to calculate the total temporal response of the fibre. The scheme of the experimental apparatus is shown in fig. 9a, where the optical source is a LOC GaAs laser with peak emission at $0.9 \mu\text{m}$. The input pulse as obtained from the laser is shown in fig. 9b.

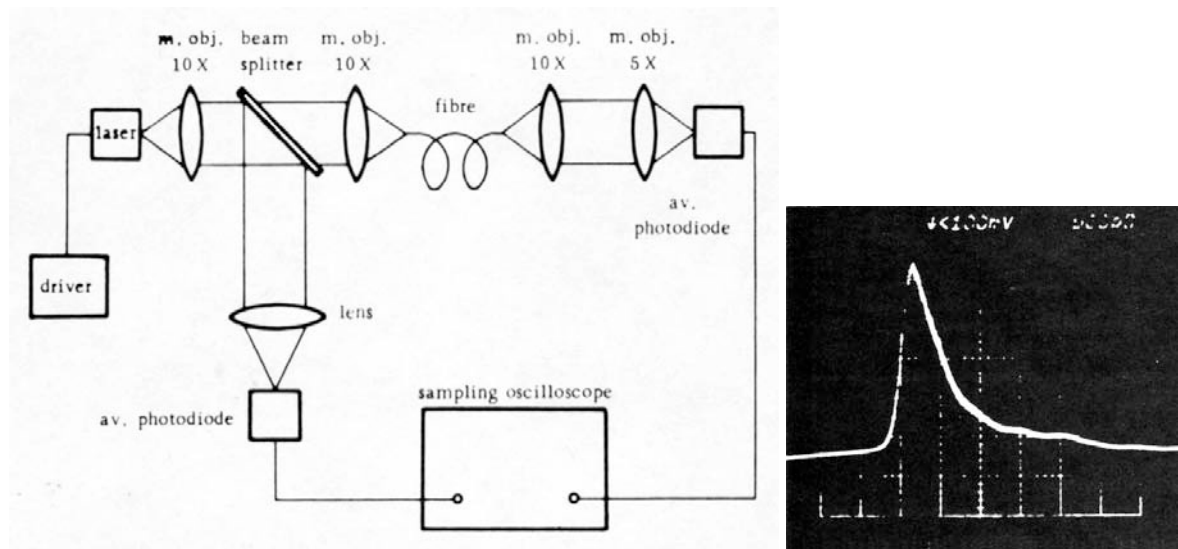

Fig. 9a (left) - Experimental arrangement for pulse distortion measurement. Fig. 9b (right) - Input pulse in the setup of fig. 9a

The various stages at which these measurements were performed are listed in Table 2.

Stage	Conditions	Company	Where	When
(A)	Before shipping fibres to Italy	Corning	Corning, NY	1975
(B)	After rewinding of the fibres	Pirelli	Milano	Jan. '76
(C)	After jacketing of the fibres	Pirelli	Milano	9 Feb '76
(D)	After stranding of the cable core	Pirelli	Milano	16 Feb '76
(E)	After sheathing of the cable	Pirelli	Milano	18 Feb '76
(F)	After transportation from Milano to Torino	CSELT	Torino	3 Mar '76
(G)	After laying of the cable	CSELT	Torino	1 Apr '76
(H)	After pressurization	CSELT	Torino	26 Apr '76
(I)	After approx. one month from (H)	CSELT	Torino	10 Jun '76

Table 2 - Description of the various stages at which the measurements were performed

It must be noted that the attenuation measurements were performed in three different laboratories, at very different times, and with similar but not identical test setup; the pulse distortion measurements were carried out only at CSELT starting from stage (F) of Table 2.

Attenuation measurement results at 820 nm are summarized in fig. 10, where the attenuation changes $\Delta\alpha$ relative to the initial attenuation values as measured at Corning are reported.

In fig. 11 the output pulses from each fibre of the cable, as displayed on the sampling oscilloscope at stages F, G, H and I are shown.

The examination of the above results leads to the conclusion that, in general, the fibres do not show, apart from one of them, large changes in the attenuation, especially if one takes into account the already mentioned fact that the different groups of measurements were performed in different

laboratories and conditions. In particular, it can be noted that, after the laying of the cable, the measured changes fall, in most cases, within the above cited error range of the measurement itself; in order to decide whether such small changes are due to actual attenuation variations of the fibre or not, a better resolution would be necessary: this can be accomplished by improving the repeatability of the coupling conditions and by setting up a measurement ensuring the stationary behavior of the fibres, for instance through the adoption of suitable launching conditions.

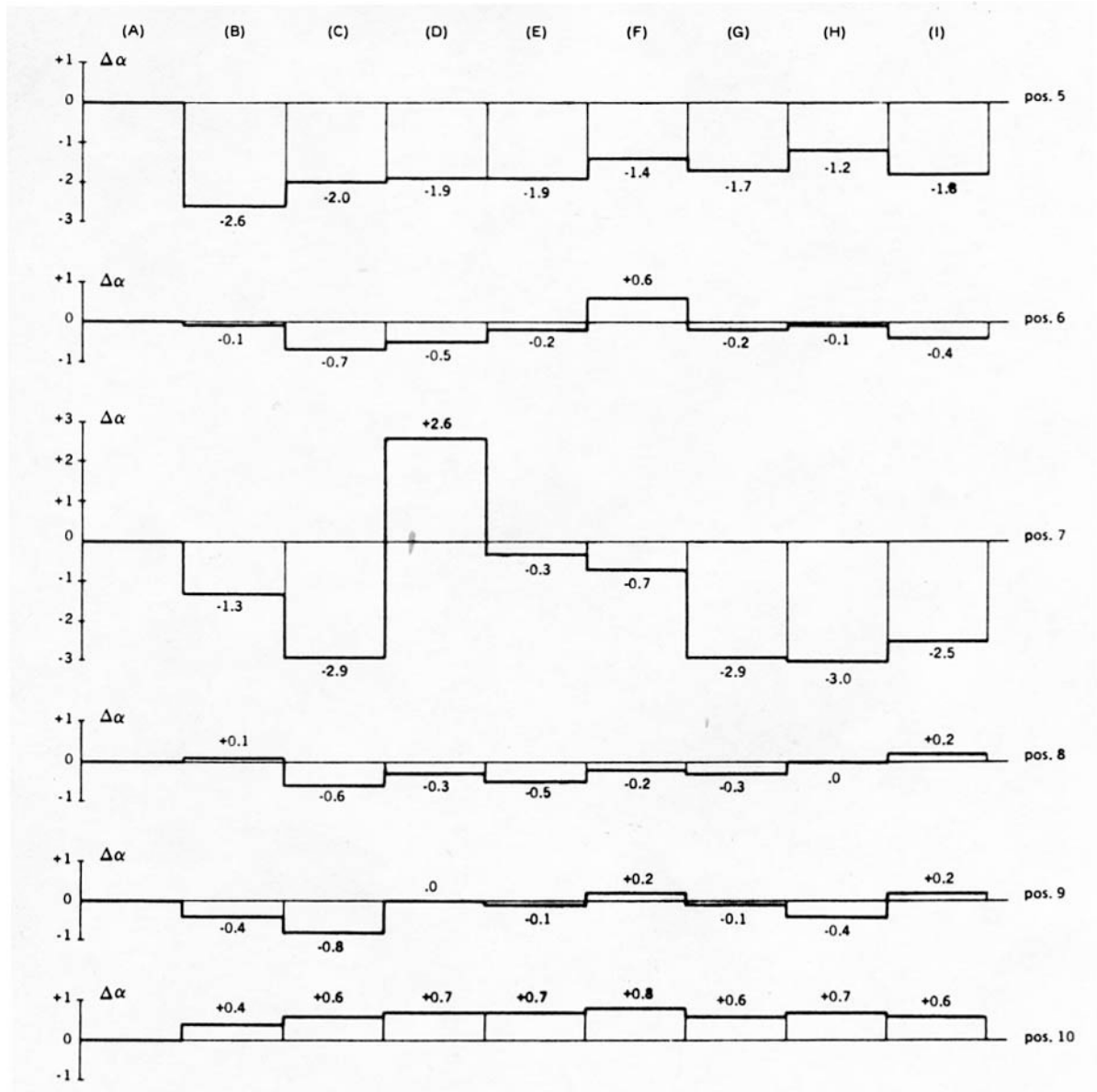

Fig. 10 - Attenuation change $\Delta\alpha$ of the fibres along the various stages of the COS 1 experiment

A somewhat different behavior from the other fibres is exhibited by the fibre in position 7, which seems to have undergone particular stresses during the stranding of the cable (D); on the other hand, the very good subsequent behavior of the same fibre in the laid down cable (G, H, I) seems to suggest that the cable design adopted in this experiment is able to relieve, at least to a certain amount, unwanted stresses which can occur during the manufacturing of the cable itself.

For what concerns the pulse response, the fibre in position 7 shows again an anomalous behavior, i.e. the pulse shape is critically dependent on the launching conditions; this can be attributed to a rather irregular refractive index profile, which can play a role also in the unstable behavior of the attenuation characteristics.

In general it seems possible to state that the small differences, where they exist, in the output pulses are not attributable to cable instabilities but rather to intrinsic characteristics of the fibres themselves

(refractive index profile, mode conversion) in connection with the difficulty of exactly reproducing the launching conditions in successive measurements on the same fibre [2].

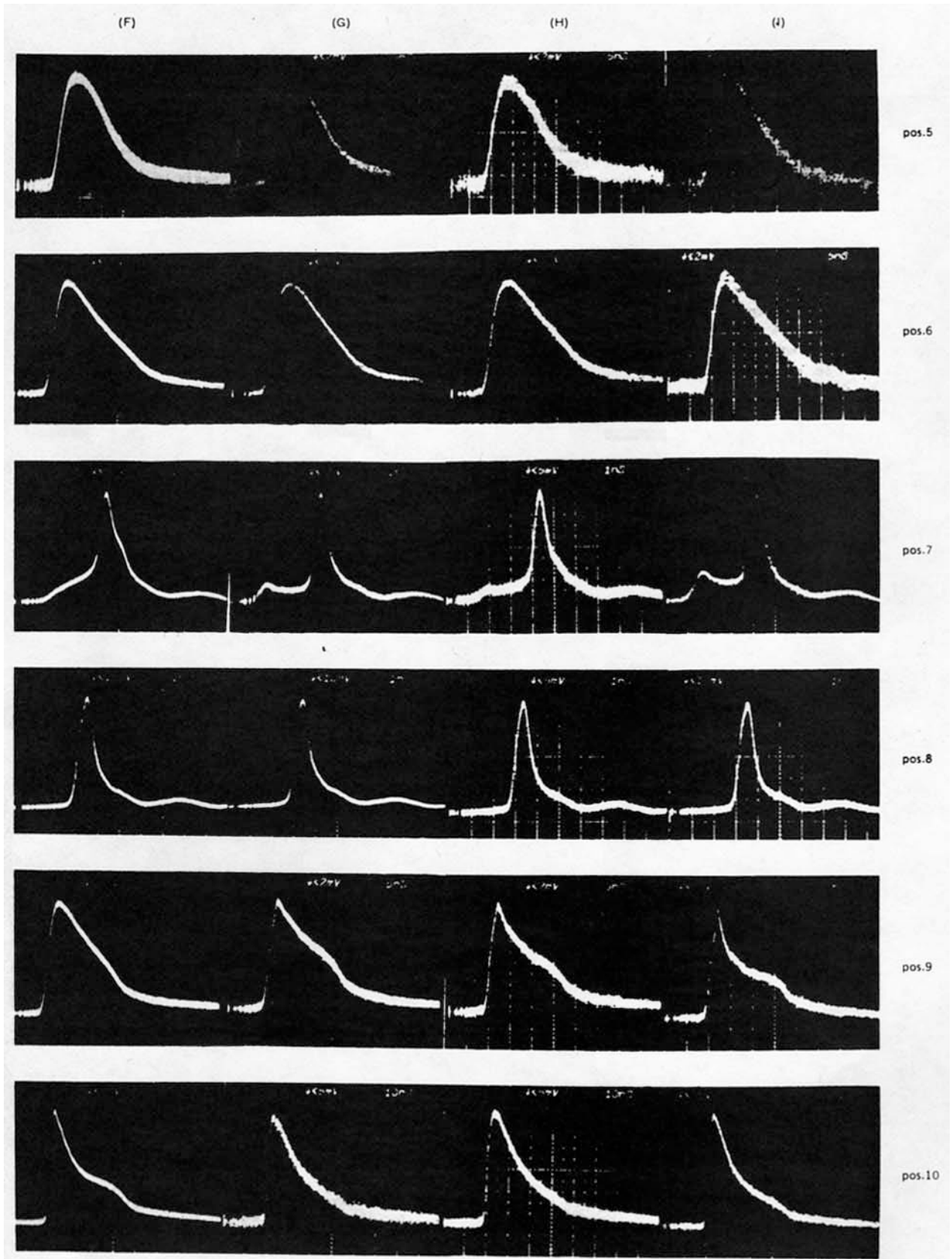

Fig. 11 – Pulse distortion test results

Cross-talk measurements between each fibre and the neighboring one were also performed, but no crosstalk was detected within the sensitivity of the attenuation measuring apparatus (-60 dB)

described above. More sensitive tests will be performed in the near future and their results will be presented in September at the Conference.

6. CONCLUSIONS

Probably, every telecommunication engineer is aware that, as it happened in the past with other transmission media, very many types of optical cables for very many years from now will be designed, manufactured and tested, before finalizing a few types, which will be used extensively in the telecommunication networks.

This first COS 1 experiment, conducted in Italy, is therefore not deemed to be exhaustive enough to proceed to a mass fabrication of optical cables. In addition to that, it seems advisable to allow at least one year (i.e. at least the four seasons) to elapse before taking provisional conclusions for what concerns the long-time behavior of the cable on site.

However, one firm positive conclusion may be drawn not only for the survivability of the optical cable, but also for the stability of its performance, after the production, shipping, stranding and assembling of the fibres and after the manufacturing, transportation and installation of the cable. It is also to be remarked that these results have not been easy to obtain; on the contrary, many years of preliminary experiments made at Corning, Pirelli and CSELT were needed to finalize this first field trial with good probability of success.

The results gathered up to now are so encouraging that, on one hand, a more severe experiment (COS 2) is planned to pull an optical cable through urban ducts and, on the other hand, improvements in the measuring sensitivity and accuracy are envisaged, to better evidencing the small performance variations detected up to now.

BIBLIOGRAPHY

- [1] "Demonstration of 34 Mb/s Digital Transmission through Optical Fibres" - CSELT Monograph distributed at the 23rd International Exhibition of Electronics, Nuclear Energy and Aerospace Technology, Rome 18-28 March, 1976, where a working 4 km 34 Mb/s experimental system was shown.
- [2] B. Costa, B. Sordo: "Experimental study of pulse distortion in some optical fibres" Proceedings of the 23rd International Scientific Congress on Electronics, Rome-EUR 22-24 March 1976, p. 413.